

EN Rechargeable LED Solar Lighting Solight WO785-1

Dear customer, thank you for purchasing our product. Please read the following instructions carefully and follow them to serve you safely and to your full satisfaction. This will prevent misuse or damage. Avoid unprofessional handling of this appliance and always observe the electrical appliance usage guidelines. Keep the instruction manual carefully.

Specifications

Power input	max. 11W	Light sensitivity setting	10-1000lux
Luminous flux	1200lm	Max. detection distance	8 m
Light temperature	3000K, 4000K, 6500K	Sensor detection angle	160°
Battery	Li-Ion 3.7V 4400mAh	Solar panel	2,5W, 5V
Net luminous time	min. 1hr.	Class of protection	IP54
Reflector dimensions	16x18,5x4cm	Panel dimensions	18x15x1,7cm

Product description

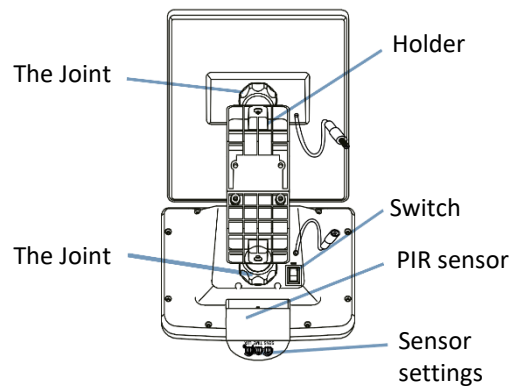
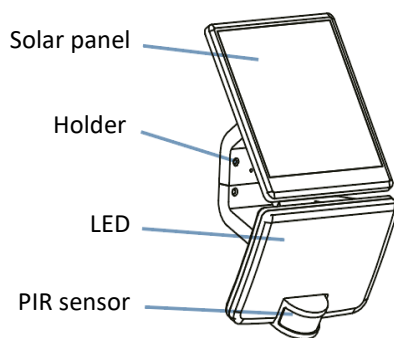

Preparation before installation

Before assembly, build the parts as shown in the pictures below:

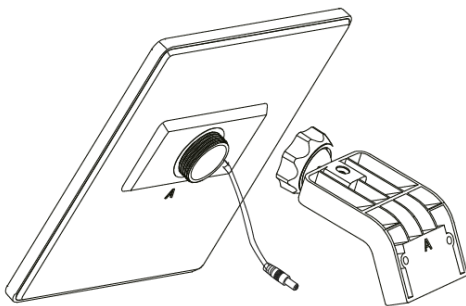

Attach the bracket marked "A" to the back of the solar panel (also marked "A") and tighten the hinge by hand.

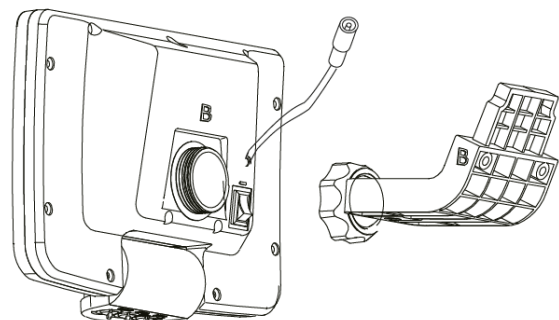

Attach the bracket marked "B" to the back of the lamp (also marked "B") and tighten the hinge by hand.

Installation - Option 1

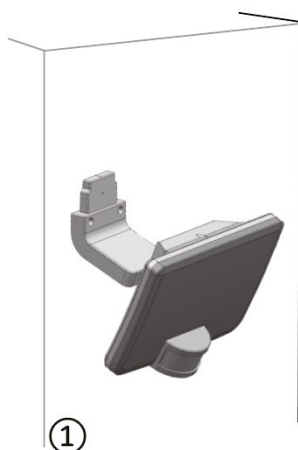

Fix the luminaire to the wall using the screw holes.

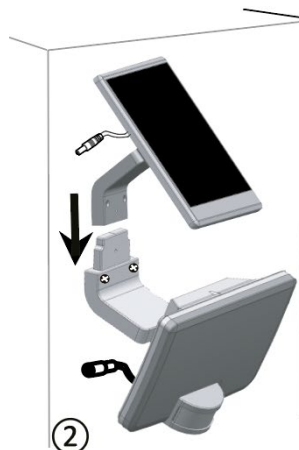

Slide the solar panel with bracket "B" onto bracket "A" on the luminaire and secure with

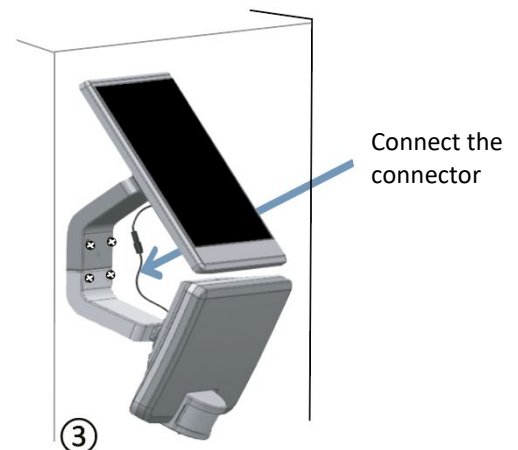

Connect the solar panel to the luminaire

Installation - Option 2

1. Fix the luminaire to the wall using the screw holes.
2. Attach the solar panel to the wall using the screw holes.
3. Connect using the supplied cable.

Note

1. Leave the light off and let it charge for at least 10 hours
2. Switch ON the luminaire using the button on the back.
3. Adjust the light time (TIME), light sensitivity (LUX) and motion sensitivity (SENS) with the switches on the bottom of the luminaire
 - TIME: can be adjusted 10s-60s
 - SENS: can be adjusted 1m-10m
 - LUX: can be adjusted 10lx-10,000lx
4. Adjust the light colour using the switch on the back.
5. The PIR sensor, light and solar panel can be set at different angles.

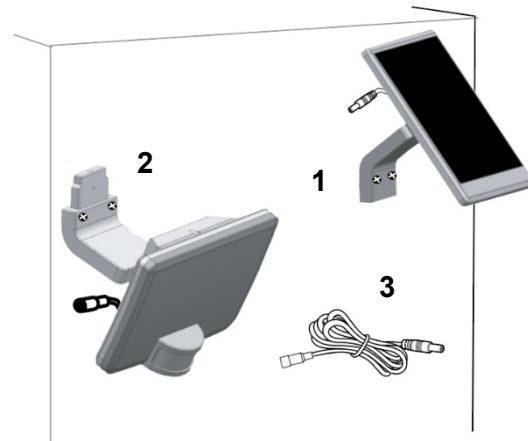

Sensor and light duration settings

The rotary controls on the underside of the reflector allow you to adjust the time of illumination (TIME). The time can be set in the range of 10-60 seconds. If motion is detected more than once within the same time interval, the time is accumulated. The sensitivity of the triggering depends on the ambient light conditions. If you have small pets, you can reduce the motion sensitivity so that the light does not switch on unnecessarily.

Lighting modes

I When the ambient light level is low, the night light will automatically turn on. When motion is detected, the main light will turn on and automatically turn off after the set time has elapsed

II. When the light conditions are met and motion is detected, the light will turn on. After the set time has elapsed, it will automatically turn off.

○ Light off (does not affect charging).

Charging and maintenance

Charging takes place automatically on sunny days. A full charge takes about 10 hours on summer days. In winter about 3 days. Keep the solar panel clean for maximum efficiency.

The light source of this luminaire is non-replaceable, at the end of its service life the entire luminaire must be replaced and disposed of in a designated place.

Producer: Solight Holding, s.r.o., Na Brně 1972, Hradec Králové 500 06

